



Municipal Street Naming and Addressing Guide

City of Richmond Hill
Planning and Infrastructure Department
January, 2021

TABLE OF CONTENTS

SECTION 1: Street Naming

- 1.1 Street Naming Process
- 1.2 Categories of Street Names
- 1.3 Suitability and Appropriateness of Street Names
- 1.4 System for Assigning Street Name Suffixes

SECTION 2: Street Addressing

- 2.1 Street Addressing Policies
- 2.2 Street Address Change Policies
- 2.3 Street Addressing Process

SECTION 3: Conclusions and Recommendations

LIST OF FIGURES

1. Street Suffixes
2. Yonge Street as the Reference Point
3. Exception to the Even vs. Odd Rule
4. Addressing on a Court
5. Number on a U-shaped Crescent
6. Addressing on a U-Shaped Crescent
7. Assigning "A" to an Address
8. Calculation based on Required Lot Frontages
9. Residential Blocks
10. "Addressing" for Blocks
11. Addressing for Corner Lots
12. Street Name Change at the Intersection
13. The Street Addressing Process

MUNICIPAL STREET NAMING AND ADDRESSING GUIDE

The function of municipal street naming and addressing is to enable people to locate properties readily. In order to provide for orderly growth within the City, a uniform system to assign street names and addresses, as established by the City accomplishes this objective.

Many problems can occur when properties are addressed in an ad-hoc manner resulting in inconsistent addressing schemes within the City. The most apparent problem is that encountered by Emergency Services in locating a particular street and/or address which can result in delayed response times. For businesses that deliver packages, newspapers, mail, etc., properties with addresses that are difficult to locate may result in inefficient delivery at an added expense. This can also apply to those who use addresses frequently in providing specific services such as, utilities, water, power, gas, garbage collection, etc. Further, traffic accidents may result when motorists are searching for a poorly addressed property. It is therefore important to adopt a consistent approach for assigning street names and addresses in order to avoid these problems.

1.0 STREET NAMING

The naming of new public and private streets is the responsibility of City Council. Street names proposed by the proponent of a development which incorporate new public or private streets, any interested body, or any City citizen are subject to Council approval.

The Planning and Infrastructure Department is responsible for processing street name requests for consideration by Council including the coordination of approval with the Region of York's Community Planning and Development Services Department and the City's Emergency Services staff. Street name requests are evaluated for suitability and appropriateness based on conformity with the street naming and addressing policies contained herein.

Approved street names are to be placed on the City of Richmond Hill **Approved Street Name List** for future use. Only approved street names may be assigned to public and private streets. The Planning and Infrastructure Department is responsible for maintaining the Approved Street Name List and all records related thereto. Council may, at any time, direct that a street name on the Approved Street Name List be used for the naming of a specific street.

1.1 Street Naming Process

The Process for Approving a Street Name(s)

1. A written request is submitted to the Planning and Infrastructure Department. The request is to include a brief but complete explanation of the reasons for the proposed name(s), which of the street name categories in

Section 1.4 the proposed name(s) would be categorized, and any specific street the name would apply to (only if it relates to a specific development).

2. Proposed street name(s) is circulated to the Region of York Planning Department and the City's Emergency Services staff to check for similarities and duplications with any existing street names within the City and Region.
3. Where the Region of York and the City's Emergency Service staff have no concerns with the proposed street name(s), the proposed street name(s) will be presented to Council for consideration.
4. If a proposed street name(s) is found to be similar or a duplicate of an existing street name, the applicant may propose another street name(s) for approval or proceed with the current proposal and seek Council's consideration (please note that staff would recommend that the proposed street name(s) be denied on the basis of the preceding consideration.)
5. For proposed street name(s) that are presented to Council for consideration, staff will provide a recommendation based on conformity with the City's street naming policies.
6. Where a proposed street name(s) is recommended for approval, staff will advise which of the categories set out in Section 1.2.5 that the street name(s) shall be placed on the Approved Street Name List.
7. Where an approved street name(s) is intended for a specific development, the street name(s) is placed on the Approved Street Name List and will be reserved for use within the development.
8. Council's decision is final and binding.

The Process for Assigning an Approved Street Name(s)

1. The proponent of a development reviews the up-to-date Approved Street Name List for street name(s) selection.
2. For any new public or private streets within a development, excluding the extension of any existing streets, a minimum of one street and no less than 50% of all streets must be assigned a street name(s) from the Approved Street Name List based on the first five priority categories as set out in Section 1.2. This selection excludes approved street name(s) that were proposed by the proponent (i.e. within a development with two new streets, one street must be assigned a name from the five priority categories in Section 1.2.5, and the other street may be assigned a Council approved street name that was proposed by the proponent).

3. Selected street names are reserved for use within the proposed development and are to be shown on future draft and approved plans.

Private Street Names

1. All Private streets in low-rise multi-residential developments within the City of Richmond Hill shall be named.
2. Private streets are defined as any shared vehicular access to or egress from residential dwelling units located on a lot, and may include parts of the lot used for vehicular access to or egress from the residential dwelling units that are described as a common element or part thereof of a common element condominium, but does not include any highways defined in Chapter 25, Section 26 of the *Municipal Act*.
3. The following is the process by which the City will enact a street name on a private street:
 - a. The proponent of a low-rise multi-residential development proposal shall submit the following in conjunction with a Site Plan Application:
 - i. prescribed application;
 - ii. prescribed application fee;
 - iii. site plan depicting all proposed private streets and associated proposed street names.
 - b. The proposed street names are reviewed in accordance with the policies of this Guide;
 - c. Notice to pass a Street Naming By-law is to be provided in accordance with By-law No. 170-07, as amended or its successor;
 - d. The street naming by-law is forwarded to a Council meeting for adoption;
 - e. The effected street names are to be depicted on the related Site Plan application drawings;
 - f. The street name signage requirements are to be fulfilled as part of the Site Plan Agreement.

1.2 Categories of Street Names

Honouring Those Who Have Given Their Life in Public Service

1. The City will facilitate the naming of streets after City residents who have served and lost their lives in the Canadian Armed Forces. Secondly, the names of those who have lost their lives in public service either through the York Regional Police or the City of Richmond Hill Emergency Services shall also be honoured.

Where street names are proposed in a new development, a minimum number of street names honouring those who have given their life in public service, based on the number of streets in the development will be required as follows:

Number of Private and/or Public Streets Proposed	Minimum Number of Names Required in Accordance with the Above
1 - 4	1 Name
5 - 9	2 Names
10 or More	3 Names

2. Consent is to be given by the person's family.
3. Special signage containing the Poppy symbol is to be used for all veteran street names.

Charitable Auction Names

1. Any local charity may request permission from Council to auction an opportunity to name a street as part of a fundraising event. The local charity must meet the following criteria:
 - the charity office should be based in Richmond Hill or have a local affiliation; and,
 - the charity must provide a letter indicating where the funds to be raised will be directed.
2. Prior to the fundraising event, the charity must first obtain Council's approval to auction the opportunity to name a street.
3. If Council grants approval to auction the opportunity to name a street, the charity must submit written details about the proposed display and wording for the fundraising item for approval to the Planning and Infrastructure Department. The display and wording must clearly indicate that the winning bidder's proposed street name will be:
 - a) subject to the review by Region of York and the City's Fire Department;
 - b) be in accordance with the City's street naming policies; and,
 - c) subject to Council's approval, whose decision is final and binding.
4. The display must also indicate that if the fundraising item is not related to a particular development within the City, the street name (if approved by Council) would be entered into the City's **Approved Street Name List**, and is subject to being selected at some future date by a user and is not specific to a particular street or neighbourhood.
5. The charity, at its fundraising event shall display an up-to-date copy of the City of Richmond Hill Municipal Street Naming and Addressing Guide and the City approved display and wording.
6. Upon completion of the fundraising event, the charity shall notify the City of the winning bidder's proposed street name for consideration by Council.
7. At all times, the charity will deal with the winning bidder and the City will deal with the charity or its representative.

Honouring Individuals for Community Service, Local Historical Reasons, National Reasons or International Reasons

1. Generally, a proposed street name will be of historic importance to the City, or be a name which is of importance either nationally or internationally, or lastly, be a name of a person who has been of public service to the City. A written description explaining the individual's contribution to the City and why the honour should be given, shall be submitted in writing to the City. Staff shall research any names proposed by Council.
2. Consent for the use of the name must be given by the person's family.

Other Names

1. Names that promote pride in the City, acknowledge local heritage, history, and recognize unique features and geography are appropriate. Proposed street names should meet one of following criteria:
 - a) commemorate local history, places, events, culture; or,
 - b) strengthen neighbourhood identity to reflect the character of the area; or,
 - c) recognize native wildlife, flora, fauna, natural features; or,
 - d) recognize communities that contribute to the public life of the City.
2. Names that represent specific themes are encouraged as they are easily recognizable for Emergency Services and provide consistency in large developments.

Priority for Selection of Street Names

A proponent shall select names from the Approved Street Name List in the following priority order:

- a) Names Honouring Those Who Have Served Canada;
- b) Names Honouring Those who have given their Life while in Public Service;
- c) Charitable Auction Names;
- d) Names Honouring Individuals – Local Historical;
- e) Names Honouring Individuals – National or International;
- f) Names Honouring Individuals – Community Service; and,
- g) Other Names.

1.3 Suitability and Appropriateness of Street Names

In addition to the policies of Section 1.2 Categories of Street Names, the following policies have been developed to assess the suitability and appropriateness of street names.

Ease of Spelling and Pronunciation

Street names should be easily pronounced, recognized and use conventional spelling to avoid difficulties in emergency situations. Street names should be spelled the way they are pronounced.

Individuals

Streets named after individuals shall be a posthumous honour and Council shall consider such names provided that written consent is obtained from the individual's surviving family. The honouring of a living international or national public figure requires the individual's consent.

Two Word Names

Proposed street names consisting of two words should be changed to one word. Only a person's last name should be used unless additional identification is necessary to prevent duplication with an existing street name in the City or surrounding municipalities within the Region of York.

Street Name Characteristics

Names should generally not exceed ten characters in length (including spaces). This helps ensure that the above mentioned criteria are met and that standard street signage across the City and Region are consistent.

Names to Avoid

- a) Names that could be construed as advertising a particular business;
- b) Cumbersome, corrupted, modified names, discriminatory or derogatory names from the point of view of race, sex, colour, creed, political affiliation or other social factors;
- c) Names with any sexual overtones, inappropriate humour, parody, slang or double meaning;
- d) Names that have a secondary negative or offensive connotation;
- e) Names spelled differently but sounding alike (i.e. Crosby Lane and Crosbie Lane) or having similar pronunciation but are spelled differently (i.e. Heirloom Street could be pronounced with the 'H' dropped (Eirloom Street));
- f) Use of complex words (ex. Quetico Drive); and,
- g) Names with hyphens, apostrophes or dashes are discouraged and only considered on a case by case basis provided other criteria have been met.

1.4 System for Assigning Street Name Suffixes

Street name suffixes are assigned in accordance with the following (refer to Figure 1):

- "Street" - all streets which run in a general north-south direction, parallel to Yonge Street.
- "Avenue" - all streets which run in a general east-west direction.
- "Drive" - all streets which run in a general north-south direction, but gradually change to an east-west direction, or vice versa.
 - meandering is the main characteristic.
 - where a sharp right-angle turn has to be negotiated, it may be applicable to use Street and Avenue designations.
- "Road" - all streets which are defined as major collector or arterial streets.
 - run in any direction.
- "Boulevard" - all streets which have a planted median divider.
- "Crescent" - all streets which intersect another street at both ends and which actually forms a crescent shape.
- "Court" - all streets which end permanently as a bulb/cul-de-sac, a "T", or a design which permits turning around.
 - all streets which have only one point of access.
- "Gate" - all streets which serve as an entry onto a court or a crescent.
 - the main characteristic is that the street is short in length and that no other streets intersect them.
- "Lane (P)" - all private streets as defined in this Guide.

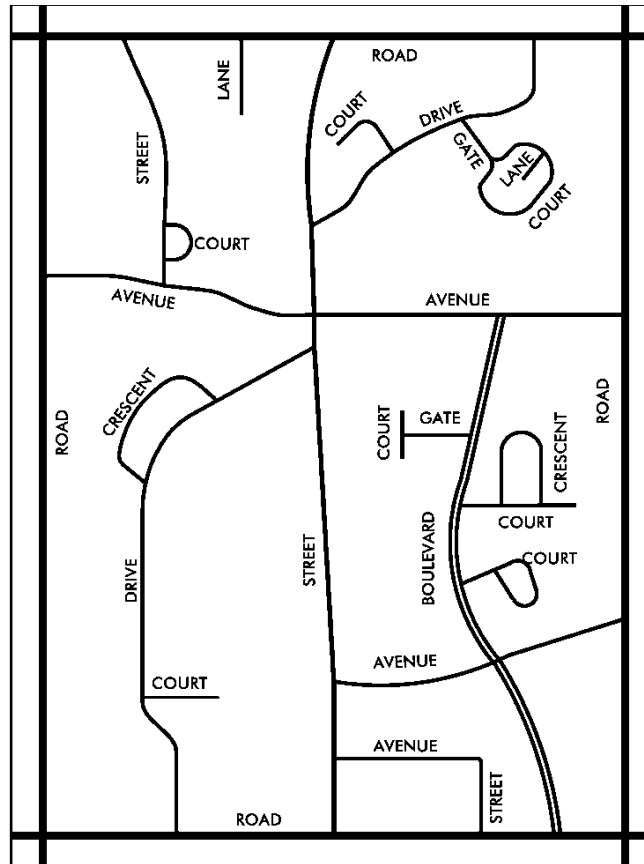

FIGURE 1 – Street Suffixes

2.0 STREET ADDRESSING

It is the responsibility of the City to assign municipal addresses in an orderly and consistent manner so that properties can be easily located. Street addressing is complex and it is necessary to have sound policies to facilitate a uniform addressing system across the City.

2.1 Street Addressing Policies

1. Yonge Street is to be used as the reference point. Addresses increase as one moves northward, and addresses increase from Yonge Street eastward and westward (refer to Figure 2). In consideration of the preceding, addresses on parallel streets should be comparable in order to maintain consistency. Further, when the street curves, the predominant direction of the street will govern how properties will be addressed, and the proposed addressing scheme must also be consistent with the existing addressing schemes in the surrounding area.

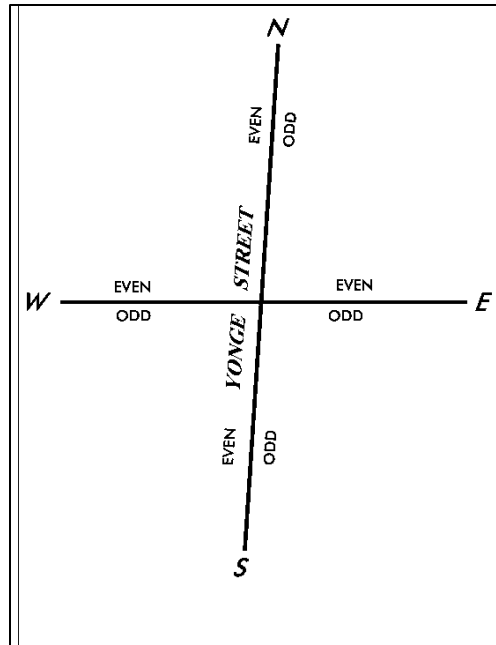
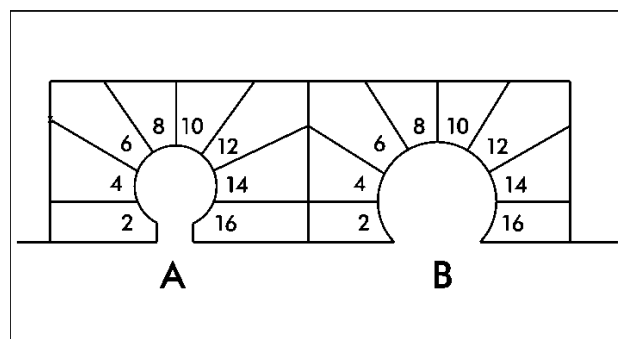

FIGURE 2 – Yonge Street as the Reference Point

2. Even numbers are assigned to the north and west side of streets, and odd numbers are assigned to the south and east side of streets. Similarly, when the street curves, the predominant direction of the street will govern which side of the street will have even or odd addresses and this must also be consistent with the existing addressing schemes in the surrounding area.
 - a) In order to be consecutive and uniform, some situations cannot adhere to the "even on the north and west, and odd on the south and east" rule. This situation occurs with small courts and U-shaped crescents (Figure 3). Small courts should only be addressed as such when there is one lot (as in A below) or less (as in B below) before the bulb.



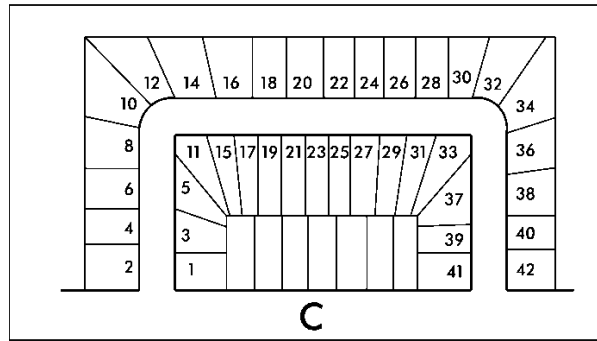

FIGURE 3 - Exception to the Even vs. Odd Rule

- b) In the case of a regular court where there is more than one lot before the bulb, the even-odd rule can apply, with the numbers meeting at the centre of the bulb (refer to Figure 4):

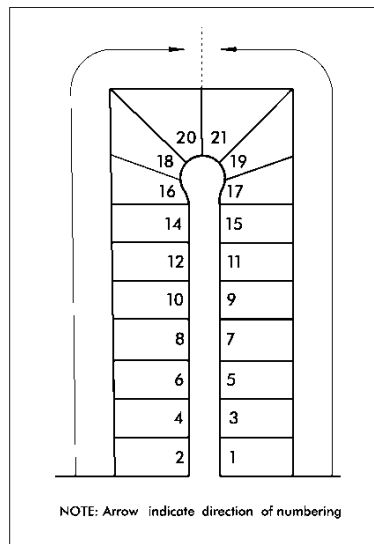

FIGURE 4 - Addressing on a Court

- c) In the case of a long, U-shaped crescent, the even-odd rule can also apply (refer to Figure 5):

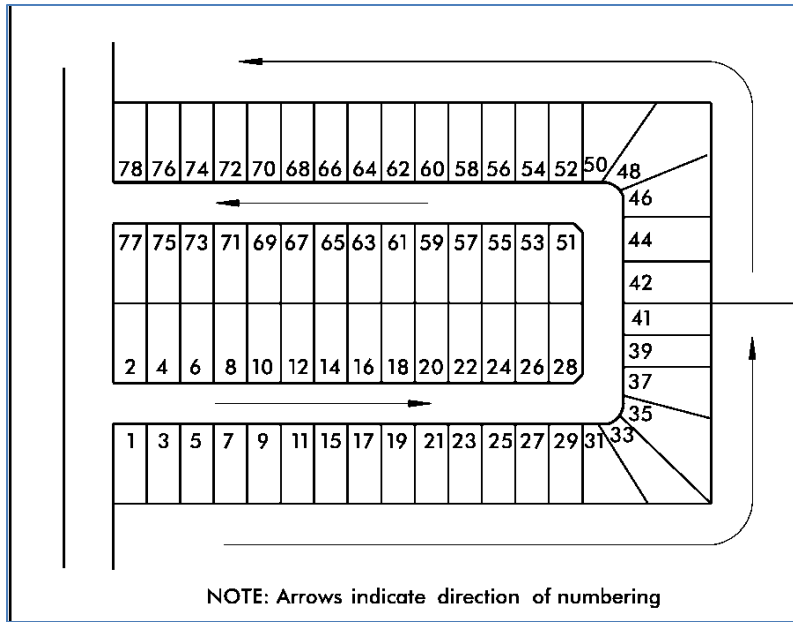

FIGURE 5 - Number on a U-shaped Crescent

3. An ideal street layout for addressing would be a grid system, but not all streets are straight, parallel and perpendicular to each other. Generally, addresses are to increase by increments of two on either side of a street. This is possible to maintain for most curved streets, except for sharply curving streets and crescents. On the inside of the bend where there are fewer lots than on the outside of the bend, if addresses were to increase by increments of two, there would be a discrepancy when the street straightens (or when the crescent ends) (refer to Figure 6). It is preferable to skip addresses (i.e. increase by increments of four or more on the inside of the bend) so that uniformity is maintained and the addresses align on either side of the road.

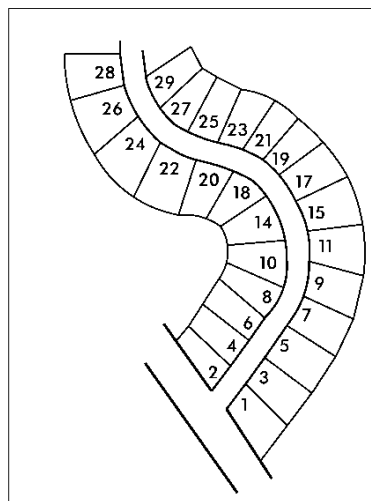

FIGURE 6 - Addressing on Curved Streets

4. In some of the older, more established areas of City where there are infill opportunities for lots to be severed, there may not be an adequate supply of reserved addresses for newly created lot(s). In order to be consecutive and uniform, and without creating a confusing situation, the newly created lot(s) will be assigned the same address (as the original lot) and denoted with the letter suffix (i.e. A, B, C, etc). This is the only case in which a letter suffix will be assigned to a street address (refer to Figure 7):

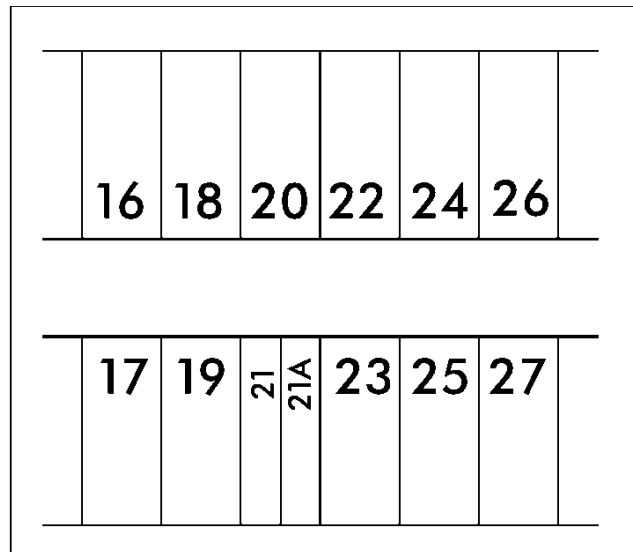

FIGURE 7 - Assigning "A" to an Address

5. Addressing on extensions of existing streets should be consistent with the established pattern, and the endpoint should be double checked in order to avoid duplication.
6. There should be coordination of addresses between new Plans of Subdivision so that beginning and endpoints do not have duplicate addresses. In areas where it is known that a common street will be continued in the future, an estimation based on the frontage requirements of lots for that area can be made. Therefore, the number of future lots can be calculated. Addresses should be reserved based on this estimation (refer to Figure 8), but not assigned formally until the Plan of Subdivision is registered.

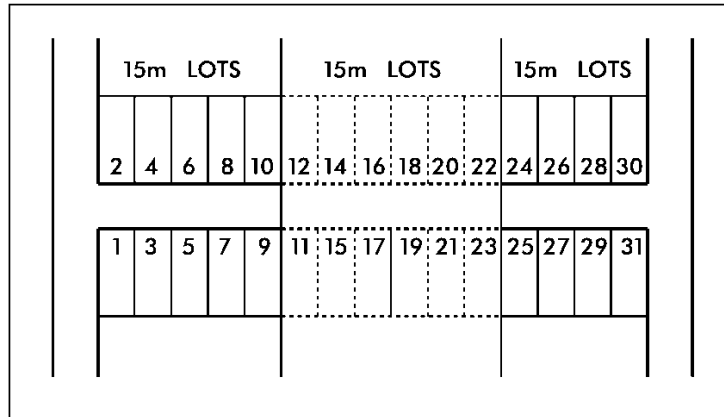

FIGURE 8 - Calculation based on Required Lot Frontages

- a) Remnant blocks under different Plans of Subdivision that abut each other usually form to create one or more building lot (refer to Figure 9). An estimation based on the frontage requirements of lots for these remnant blocks can be made. Therefore, the number of future lots can be calculated. A set of addresses should be reserved for these future lots, but not assigned formally until both Plans are registered (refer to Figure 10).

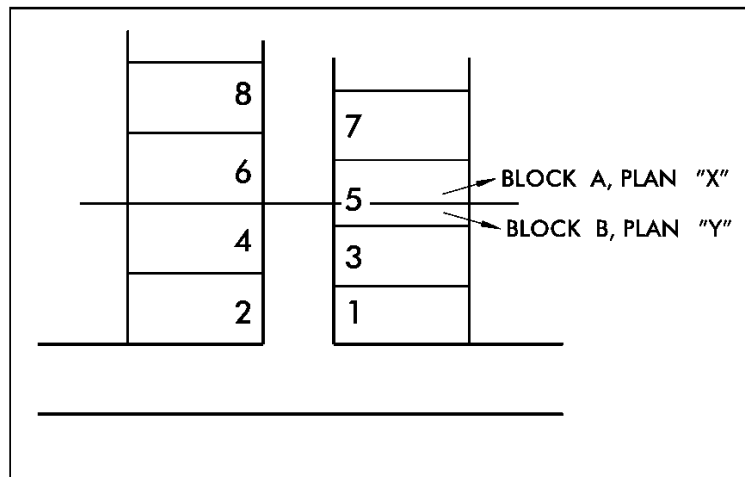

FIGURE 9 - Residential Blocks

- b) Blocks for industrial, commercial or institutional development are also measured based on required frontages. A set of addresses are reserved to be assigned on a per building basis.

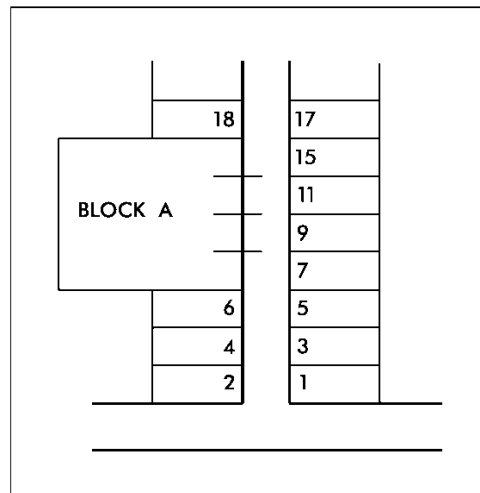

FIGURE 10 - "Addressing" for Blocks

- c) A park or open space block requires an address assigned to the primary access point, which is based on the following hierarchical criteria:
- i) the entrance from the same street as the neighbouring community centre (it will receive the same address as the community centre;
 - ii) the primary entrance for vehicular access;
 - iii) the entrance which the largest frontage of the park sides on; or,
 - iv) the entrance closest to the concentration of outdoor recreation facilities.

Further to the above noted criteria, the addressing of parks and open spaces must be assessed on a site specific basis with consideration for existing site conditions such as topography and vegetation. It is therefore important to consult with applicable departmental staff to determine the most appropriate primary access point to be addressed and if additional addresses are required for any secondary accesses.

- d) It is also important that when the addressing continues on the other side of a block within a Plan of Subdivision, that it also matches with the addressing across the street.
7. Addressing for properties with frontage on arterial roads should be based on an established "address per linear foot" basis. The City has already implemented a system of assigning an address for each 17.6 feet (5.36 metres) of frontage along its north-south and east-west arterial roads. This is consistent with the Region of York's recommended addressing system as referred to in its report, ***Towards a Regional/Municipal Addressing System on Arterial Roads in York Region***, dated December, 1986.

8. The Planning and Infrastructure Department will assign addresses to newly created lots in registered Plans of Subdivision. Draft addresses may be assigned to the most up-to-date draft Plans that will be sent for registration purposes. Problems are encountered when residents do not like their address as assigned, and request an address change that cannot be accommodate based on the existing and/or proposed address scheme.
9. Addressing of residential corner lots shall be based on the orientation of the front door and/or the lesser street frontage.
10. Addressing of corner lots will begin with numbers '1' and '2'.
11. When continuing the addressing on the other side of the street, usually addresses are skipped in order to match with the addressing across the street (refer to Figure 11).

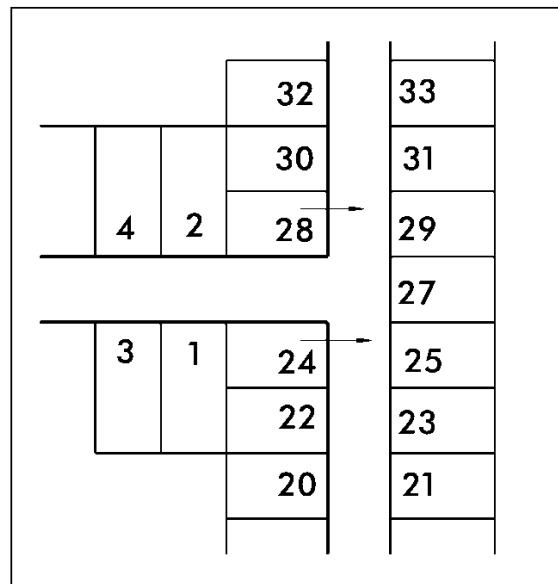
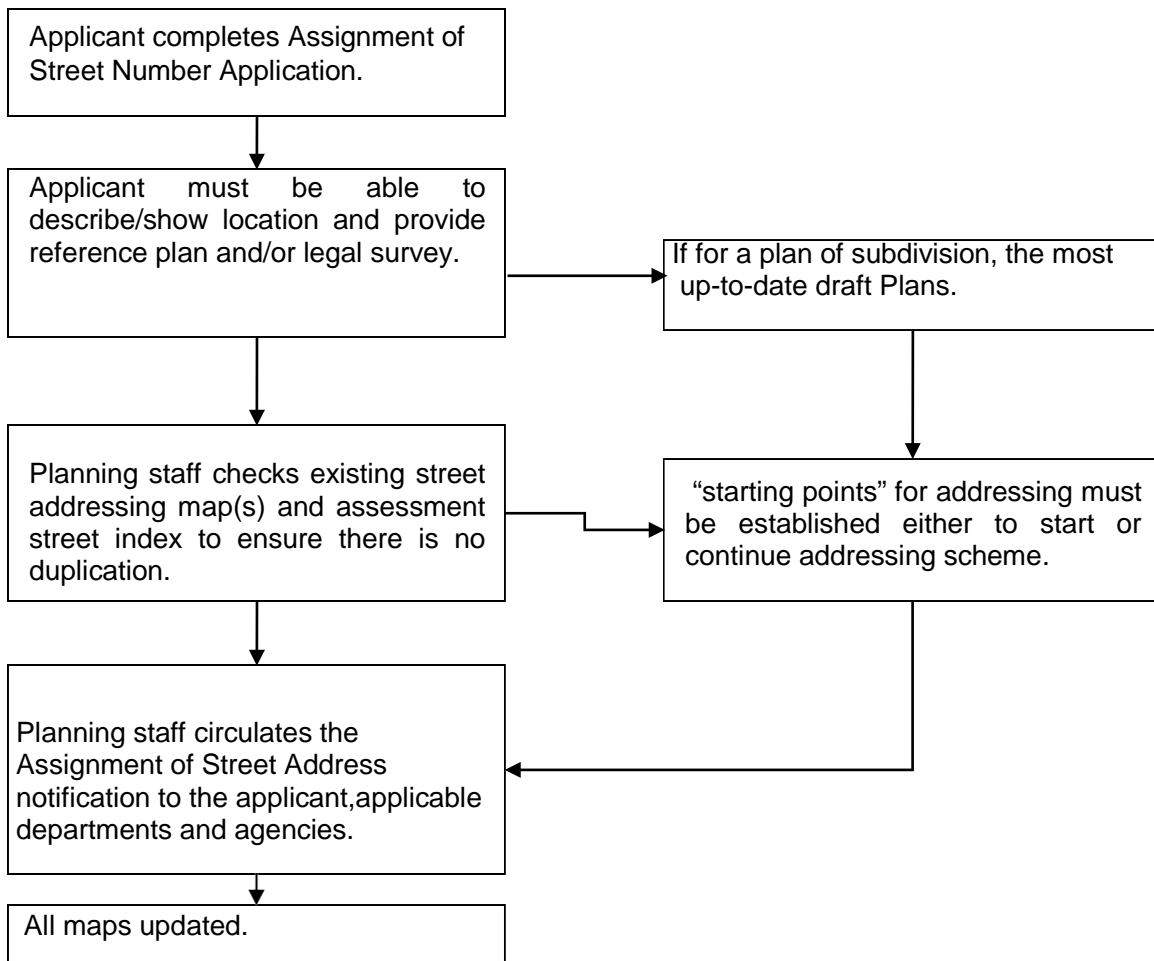

FIGURE 11 - Addressing for Corner Lots

12. Residential lots should have only one address assigned to them as there is only one dwelling per lot.
13. The number "13" is to be skipped when assigning addresses.

2.3 Street Addressing Process

The process for assigning addresses is summarized in the following flow chart:



The following stakeholders are circulated a copy of the Street Address Notification document.

- Owner/Applicant
- Planning and Infrastructure Department, various divisions
- Finance Department
- York Region Assessment Department
- Enbridge Gas Distribution
- Alectra Utilities
- Municipal Property Assessment Corporation (MPAC)
- Bell Canada - various divisions
- Canada Post
- Central Ambulance Communication Centre

3.0 CONCLUSIONS AND RECOMMENDATIONS

It is important to adopt a consistent approach for assigning street names and addresses. Many problems can be avoided if these policies are applied:

1. All public and private streets are to be named;
2. Avoid any duplication of street names;
3. Avoid street names that sound similar, even if they have a different suffix (i.e. street vs. road, etc.);
4. Coordinate draft Plans of Subdivision to ensure that streets are assigned one name for their entire length;
5. Assign two different names to a street broken by an intervening land use (for example, a valley, train tracks, etc.);
6. Maintain continuity when assigning suffixes (i.e. Crescent, Avenue, etc.);
7. Give consideration to grouping names by themes for certain areas;
8. Avoid long street names;
9. Ensure that when new street names are proposed, that they fall into one of the established categories of street names;
10. Update Emergency Services and all necessary departments and external agencies about any newly assigned street names and addresses;
11. Use Yonge Street as a reference point - addresses increase northward, eastward, and westward;
12. Even numbers are assigned to the north and west side of streets and odd numbers are assigned to the south and east sides, with certain exceptions for curved streets;
13. Keep in mind the predominant direction of curved streets when addressing, and maintain consistency with the existing addressing schemes in the surrounding area;
14. Addresses should match on either side of the street to maintain a uniform addressing scheme;
15. Addresses increase consecutively by increments of two, with certain exceptions for curved streets;
16. Do not duplicate addresses. Assign a letter (i.e. A, B, C etc.) to a duplicated address only in the case of infill development where no reserve addresses are available for newly created lots;
17. Addressing should accommodate future growth;
18. Coordinate draft Plans of Subdivision to ensure the overall addressing scheme is uniform and consistent, and that beginning and endpoints are verified;
19. Estimate possible future lots based on the frontage requirements in the by-law for that area;
20. Addressing of properties on arterial roads is based on assigning one address for each 17.6 feet (5.36 metres);
21. Do not address remnant blocks in Plans of Subdivision;
22. Address Plans of Subdivision when the most up-to-date draft Plans are ready for registration purposes;
23. Assign addresses to the shorter side of a corner lot;
24. Assign one address to residential lots, but industrial, commercial and institutional properties is assigned addresses on a per building basis;
25. Do not assign number "13"; and,
26. Changes in street names can only occur at intersections with adjoining streets.